

CES-Cable Entry Systems



CESS-Cable Entry Systems





Frame Height: 17mm

CES 6 Standard cable entry frame

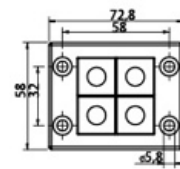
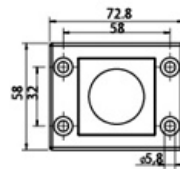

Material: Nylon 66, halogen free
 Color: Black
 Temperature: -40°C-140°C
 Protection level: IP54/IP65 (with gasket and correct selection of the cable inserts)
 Flame Class: UL94: V0
 Cut-out dimensions: 46x46mm

Type	Inserts Small/large	Order No.	PU
CES6/1	Insert Medium	600101	5
CES6/4	Insert Small	600102	5

CES 10 Standard cable entry frame

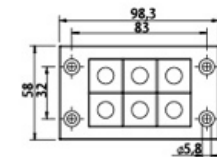
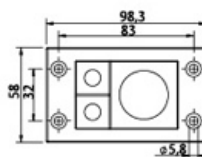

Material: Nylon 66, halogen free
 Color: Black
 Temperature: -40°C-140°C
 Protection level: IP54/IP65 (with gasket and correct selection of the cable inserts)
 Flame Class: UL94: V0
 Cut-out dimensions: 36x65mm

Type	Inserts Small/large	Order No.	PU
CES10/3	Insert Medium/Insert small	600103	5
CES10/6	Insert Small	600104	5

CES 16 Standard cable entry frame



Material: Nylon 66, halogen free
 Color: Black
 Temperature: -40°C-140°C
 Protection level: IP54/IP65 (with gasket and correct selection of the cable inserts)
 Flame Class: UL94: V0
 Cut-out dimensions: 36x86mm

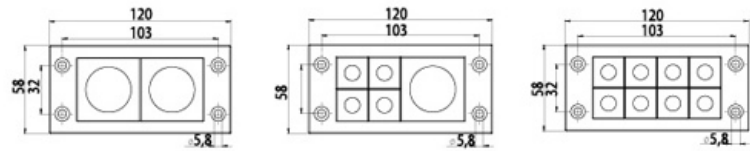

Type	Inserts Small/large	Order No.	PU
CES 16/2	Insert Medium	600105	5
CES 16/5	Insert Medium/Insert Small	600106	5
CES 16/8	Insert Small	600107	5

CES 24 Standard cable entry frame



Material: Nylon 66, halogen free
 Color: Black
 Temperature: -40°C-140°C
 Protection level: IP54/IP65 (with gasket and correct selection of the cable inserts)
 Flame Class: UL94: V0
 Cut-out dimensions: 36x112mm

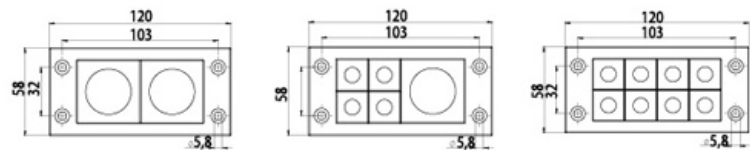

Type	Inserts Small/large	Order No.	PU
CES 24/4	Insert Medium/Insert Small	600108	5
CES 24/7	Insert Medium/Insert Small	600109	5
CES 24/10	Insert Small	600110	5

CES standard snap frame



Material: Nylon 66, halogen free
 Color: Black
 Temperature: -40°C-140°C
 Protection level: IP54/IP65 (with gasket and correct selection of the cable inserts)
 Flame Class: UL94: V0

Used to assemble CES6,10,16,24 series frame, connected with cabinet with screw bolts

Type	Order No.	PU
CES SNAP6	600111	5
CES SNAP10	600112	5
CES SNAP16	600113	5
CES SNAP24	600114	5

Standard cable entry frame with brush



Material
 Frame: polyamide (nylon)
 Brush: polyamide (nylon)
 temperature -20°C-90°C Halogen free, silicon free
 Height: 10mm

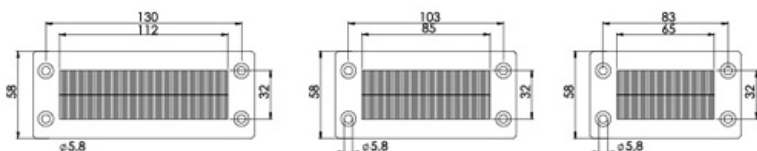

Type	Cut-out dimensions	Order No.	PU
CES BES/24	36x112mm	600431	5
CES BES/16	36x86mm	600432	5
CES BES/10	36x65mm	600433	5

brush

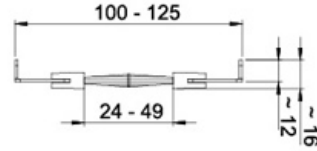
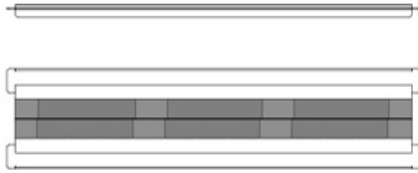

Type	Control cabinet length	Brush Length	Drilling Length	Order No.	PU
CES-BES-TS8-600	600	458mm	436mm	600434	5
CES-BES-TS8-800	800	658mm	636mm	600435	5
CES-BES-TS8-1000	1000	858mm	836mm	600436	5

Single row cable entry frame

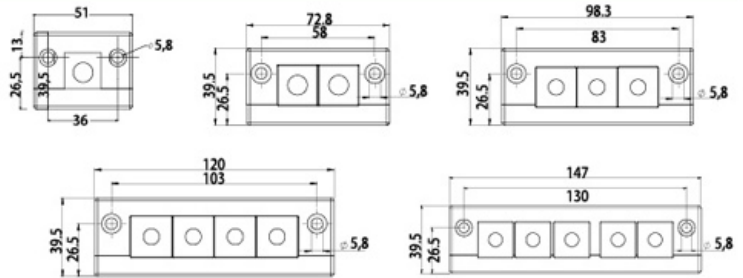

Material: Nylon 66, halogen free
 Color: Black
 Temperature: -40°C-140°C
 Protection level: IP54/IP65 (with gasket and correct selection of the cable inserts)
 Flame Class: UL94: V0
 Cut-out dimensions: E1: 24x24mm E2: 43x24mm
 E3: 65x24mm E4: 86x24mm E5: 112x24mm

Type	Inserts Small/large	Order No.	PU
CES E1	Insert Small	600437	5
CES E2	Insert Small	600115	5
CES E3	Insert Small	600116	5
CES E4	Insert Small	600117	5
CES E5	Insert Small	600118	5

CES ED double row cable entry frame

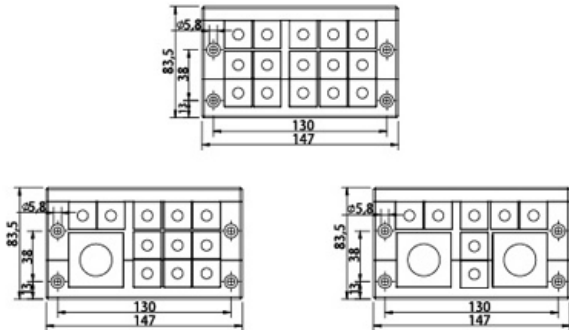

Material
 Frame: polyamide (nylon)
 Brush: polyamide (nylon)
 temperature -20°C-90°C Halogen free, silicon free
 Cut-out dimensions: 62x112mm

Type	Inserts Small/large	Order No.	PU
CES 24/15-ED	Insert small	600119	5
CES 24/12-ED	Insert Medium/Insert Small	600120	5
CES 24/9-ED	Insert Medium/Insert Small	600121	5

CES ET double row cable entry frame



Material: Nylon 66, halogen free
 Color: Black
 Temperature: -40°C-140°C
 Protection level: IP54/IP65 (with gasket and correct selection of the cable inserts)
 Flame Class: UL94: V0
 Cut-out dimensions: 82x112mm

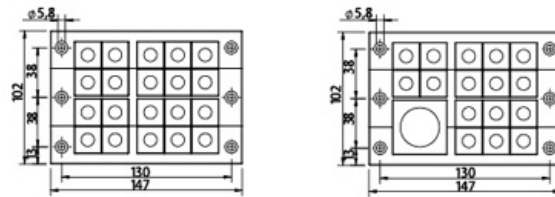

Type	Inserts Small/large	Order No.	PU
CES 24/20-ET	Insert Small	600122	5
CES 24/17-ET	Insert Medium/Insert Small	600123	5

CES ET double row cable entry frame



Material: Nylon 66, halogen free
 Color: Black
 Temperature: -40°C-140°C
 Protection level: IP54/IP65 (with gasket and correct selection of the cable inserts)
 Flame Class: UL94: V0
 Cut-out dimensions: 82x112mm

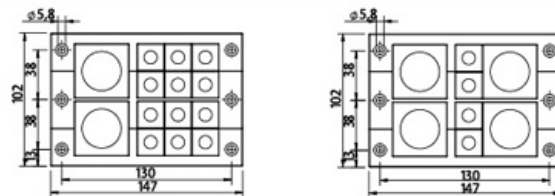

Type	Inserts Small/large	Order No.	PU
CES 24/14-ET	Insert Medium/Insert Small	600124	5
CES 24/8-ET	Insert Medium/Insert Small	600125	5

CES ET double row cable entry frame



Material: Nylon 66, halogen free
 Color: Black
 Temperature: -40°C-140°C
 Protection level: IP54/IP65 (with gasket and correct selection of the cable inserts)
 Flame Class: UL94: V0
 Cut-out dimensions: 82x86mm

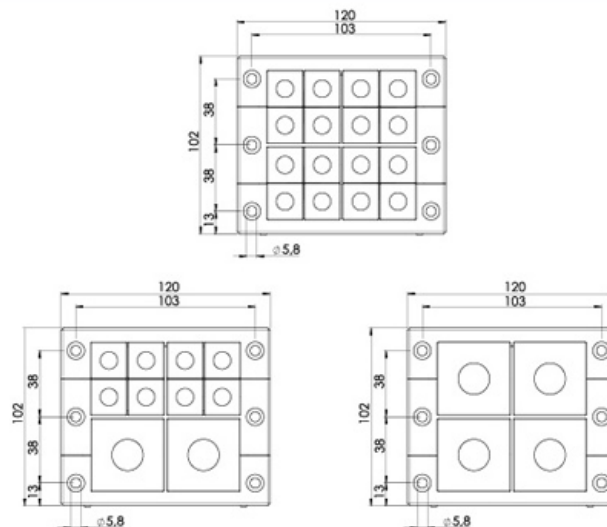

Type	Inserts Small/large	Order No.	PU
CES 16/16-ET	Insert Small	600438	5
CES 16/10-ET	Insert Medium/Insert Small	600439	5
CES 16/4-ET	Insert Medium	600440	5

CES ET Triple row cable entry frame

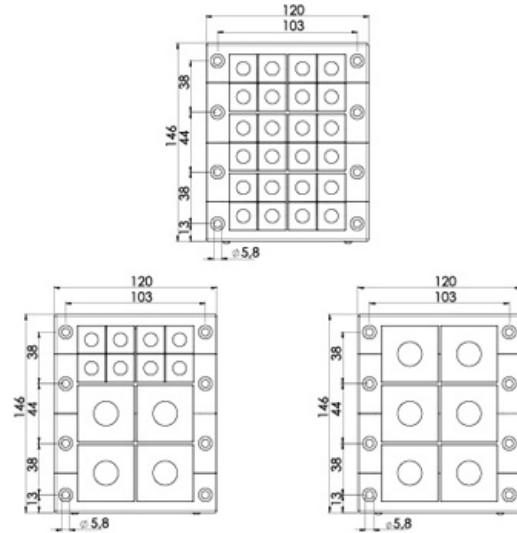

Material: Nylon 66, halogen free
 Color: Black
 Temperature: -40°C-140°C
 Protection level: IP54/IP65 (with gasket and correct selection of the cable inserts)
 Flame Class: UL94: V0
 Cut-out dimensions: 126x86mm



Type	Inserts Small/large	Order No.	PU
CES 16/24-2ET	Insert Small	600441	5
CES 16/12-2ET	Insert Medium/Insert Small	600442	5
CES 16/6-2ET	Insert Medium	600443	5

CES 2ET triple row cable entry frame

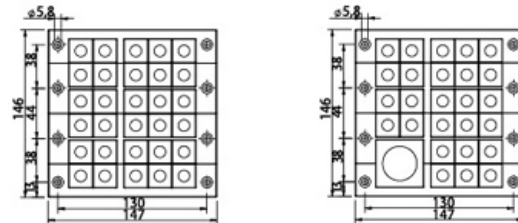

Material: Nylon 66, halogen free
 Color: Black
 Temperature: -40°C-140°C
 Protection level: IP54/IP65 (with gasket and correct selection of the cable inserts)
 Flame Class: UL94: V0
 Cut-out dimensions: 126x112mm

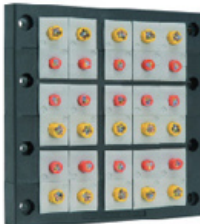

Type	Inserts Small/large	Order No.	PU
CES 24/30-2ET	Insert small	600126	5
CES 24/27-2ET	Insert Medium/Insert small	600127	5

CES 2ET triple row cable entry frame

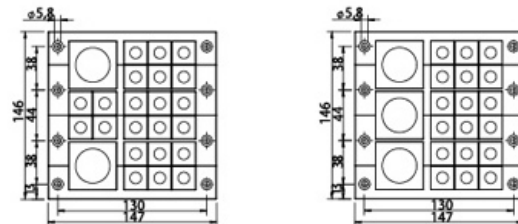
Material: Nylon 66, halogen free
 Color: Black
 Temperature: -40°C-140°C
 Protection level: IP54/IP65 (with gasket and correct selection of the cable inserts)
 Flame Class: UL94: V0
 Cut-out dimensions: 126x112mm



Type	Inserts Small/large	Order No.	PU
CES 24/24-2ET	Insert Medium/Insert small	600128	5
CES 24/21-2ET	Insert Medium/Insert small	600129	5

CES 2ET triple row cable entry frame

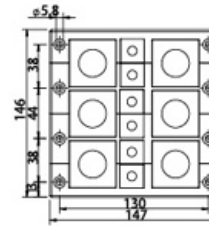
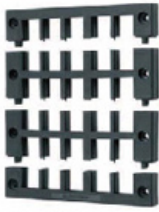

Material: Nylon 66, halogen free
 Color: Black
 Temperature: -40°C-140°C
 Protection level: IP54/IP65 (with gasket and correct selection of the cable inserts)
 Flame Class: UL94: V0
 Cut-out dimensions: 126x112mm

Type	Inserts Small/large	Order No.	PU
CES 24/12-2ET	Insert Medium/Insert Small	600130	5

Frame Height: 35mm

CES 64 Cable entry frame for large conductor

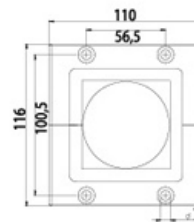

Material: Nylon 66, halogen free
 Color: Black
 Temperature: -40°C-140°C
 Protection level: IP54/IP65 (with gasket and correct selection of the cable inserts)
 Flame Class: UL94: V0
 Cut-out dimensions: Cable diameter+15-50%
 Thickness: 34.5mm

Type	Inserts Small/large	Order No.	PU
CES 64/1	Insert large	6004501	5

CES 64 Cable entry frame for large conductor

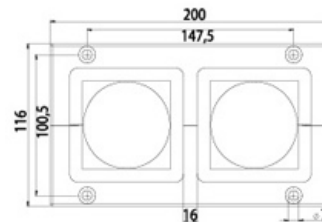

Material: Nylon 66, halogen free
 Color: Black
 Temperature: -40°C-140°C
 Protection level: IP54/IP65 (with gasket and correct selection of the cable inserts)
 Flame Class: UL94: V0
 Cut-out dimensions: Cable diameter+15-50%
 Thickness: 34.5mm

Type	Inserts Small/large	Order No.	PU
CES 64/2	Insert large	6004502	5

Cable inserts for large Conductor



Inserts for large conductor X: 34-74mm

Material: TPE, halogen free
 Color: Grey, Black
 Temperature: -40°C-140°C
 Protection level: IP54/IP65 (with gasket and correct selection of the cable inserts)
 Flame Class: UL94:V2, V0(Customized)

Type	Order No.(Grey)	Order No.(Black)	PU
CES X-(X+1)	60045X	60145X	5

Frame Height: 17mm

CES NL Cable entry frame for flat conductor



Material: Nylon 66, halogen free
 Color: Black
 Temperature: -40°C-140°C
 Protection level: IP54/IP65 (with gasket and correct selection of the cable inserts)
 Flame Class: UL94: V0
 Cut-out dimensions: 24x24mm 43x24mm 65x24mm

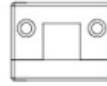

CES NL/M



CES NL/B (0xPT/1xNT-2)



CES NL/A (0xPT/1xNT-1)



CES NL/C (1xPT/1xNT-1)

Type	Order No.	PU
CES NL/M	600444	5
CES NL/A (0xPT/1xNT-1)	600133	5
CES NL/B (0xPT/1xNT-2)	600134	5
CES NL/C (1xPT/1xNT-1)	600135	5

CES NL Cable entry frame for flat conductor



Material: Nylon 66, halogen free
 Color: Black
 Temperature: -40°C-140°C
 Protection level: IP54/IP65 (with gasket and correct selection of the cable inserts)
 Flame Class: UL94: V0
 Cut-out dimensions: 86x24mm



CES NL/D (0xPT/1xNT-3)



CES NL/F (0xPT/2xNT-1)



CES NL/E (1xPT/1xNT-2)



CES NL/G (2xPT/1xNT-1)

Type	Order No.	PU
CES NL/D (0xPT/1xNT-3)	600136	5
CES NL/E (1xPT/1xNT-2)	600137	5
CES NL/F (0xPT/2xNT-1)	600138	5
CES NL/G (2xPT/1xNT-1)	600139	5

CES NL Cable entry frame for flat conductor



Material: Nylon 66, halogen free
 Color: Black
 Temperature: -40°C-140°C
 Protection level: IP54/IP65 (with gasket and correct selection of the cable inserts)
 Flame Class: UL94: V0
 Cut-out dimensions: 112x24mm



CES NL/H (2xPT/1xNT-2)



CES NL/J (3xPT/1xNT-1)



CES NL/I (1xPT/2xNT-1)



CES NL/K (1xNT-1/1xNT-2)



CES NL/L (1xNT-4)

Type	Order No.	PU
CES NL/H (2xPT/1xNT-2)	600140	5
CES NL/I (1xPT/2xNT-1)	600141	5
CES NL/J (3xPT/1xNT-1)	600142	5
CES NL/K (1xNT-1/1xNT-2)	600143	5
CES NL/L (1xNT-4)	600144	5

Inserts for flat cables



Material: TPE, halogen free
 Color: Light Grey
 Temperature: -40°C-140°C
 Protection level: IP54
 Flame Class: UL94: V0

Type	Clamping range	Order No.	PU
E1	adapter inserts	600445	5
FT-1/0	Blind Inserts	600446	5
FT-1/A	Width: 19.0-23.0mm Thickness5.5-6.0mm	600447	5
FT-1/B	Width: 28.0-33.0mm Thickness5.5-6.0mm	600448	5
FT-1/C	Width: 24.0-30.0mm Thickness8.5-9.0mm	600449	5
FT-1/F	Width: 28.0-33.0mm Thickness9.0-9.5mm	600450	5
FT-2/0	Blind Inserts	600451	5
FT-2/A	Width: 32.5-38.0mm Thickness5.0-5.5mm	600452	5
FT-2/B	Width: 45.0-50.5mm Thickness6.0-6.5mm	600453	5
FT-2/C	Width: 47.0-52.0mm Thickness9.5-10.0mm	600454	5
FT-3/0	Blind Inserts	600455	5
FT-3/A	Width: 72.0-77.0mm Thickness5.0-5.5mm	600456	5
FT-4/A	Width: 85.0-99.0mm Thickness4.2-5.2mm	600457	5
FT-4/0	Blind Inserts	600458	5

CES NG bowled angle cable entry frame



Material: Nylon 66, halogen free
 Color: Black
 Temperature: -40°C-140°C
 Protection level: IP54/IP65 (with gasket and correct selection of the cable inserts)
 Flame Class: UL94: V0
 Cut-out dimensions: 36x112mm

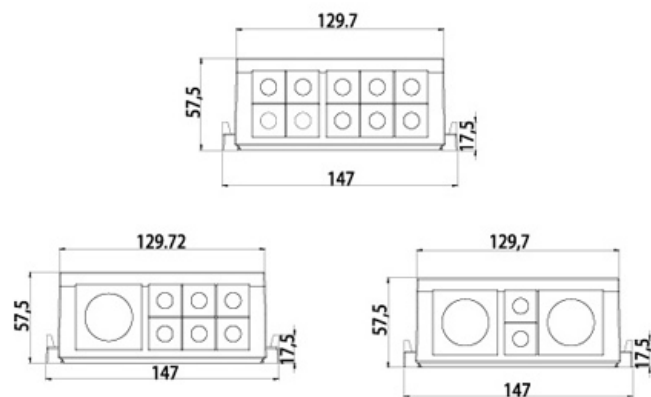

Type	Inserts Small/large	Order No.	PU
CES NG A10	Insert Small	600145	5
CES NG A7	Insert Medium/Insert Small	600146	5
CES NG A4	Insert Medium/Insert Small	600147	5

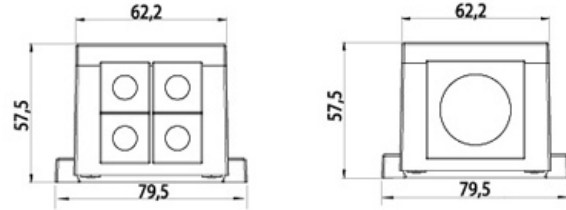
CES NG bowled angle cable entry frame

Material: Nylon 66, halogen free
 Color: Black
 Temperature: -40°C-140°C
 Protection level: IP54/IP65 (with gasket and correct selection of the cable inserts)
 Flame Class: UL94: V0
 Cut-out dimensions: 46x36mm

Type	Inserts Small/large	Order No.	PU
CES NG B4	Insert Small	600148	5
CES NG B1	Insert Medium	600149	5

CES KPF conical cable seal

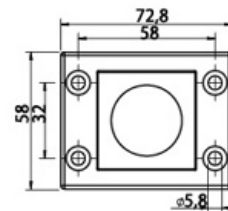

Material: TPE, halogen free
 Color: Light Grey
 Temperature: -40°C-140°C
 Protection level: IP54/IP65 (with gasket and correct selection of the cable inserts)
 Flame Class: UL94: V0

Type	Bottom External Diameter	Order No.	PU
CES KPF/M25/3-17	39mm	600163	5
CES KPF/M32/6-24	46mm	600164	5
CES KPF/M40/11-32	54mm	600165	5
CES KPF/M50/17-42	64mm	600166	5
CES KPF/M63/23-55	77mm	600167	5

CES DPF conical cable seal

Material: TPE, Nylon 66, halogen free
 Color: Light Grey
 Temperature: -40°C-140°C
 Protection level: IP54/IP65 (with gasket and correct selection of the cable inserts)
 Flame Class: UL94: V0

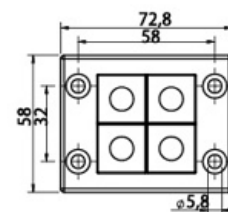
Type	Order No.	PU
CES DPF-C-SET	600168	5

CES DPF conical cable seal

Material: TPE, Nylon 66, halogen free
 Color: Light Grey
 Temperature: -40°C-140°C
 Protection level: IP54/IP65 (with gasket and correct selection of the cable inserts)
 Flame Class: UL94: V0

Type	Order No.	PU
CES DPF-4A-SET	600169	5

Accessories



Type	product description	Order No.	PU
CES BP 6		600181	5
CES BP 10		600182	5
CES BP 16	Blind plate (Zinc-plated steel)	600183	5
CES BP 24		600184	5
RH 800449		600459	5

CES RVT Split cable glands



Material: Poly carbonate (PC), halogen free
 Color: Light Grey, Black
 Temperature: -30°C-100°C
 Protection level: IP54/IP65 (with gasket and correct selection of the cable inserts)
 Flame Class: UL94: V0

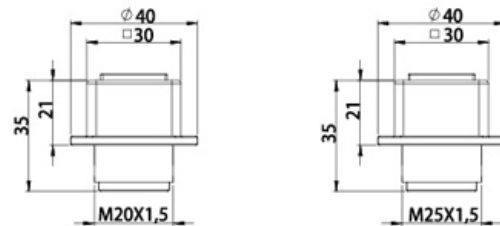

Type	Inserts Small/large	Order No.	PU
CES RVT/M20	Insert Small	600158	5
CES RVT/M25	Insert Small	600159	5

CES RVT Split cable glands



Material: Poly carbonate (PC), halogen free
 Color: Light Grey, Black
 Temperature: -30°C-100°C
 Protection level: IP54/IP65 (with gasket and correct selection of the cable inserts)
 Flame Class: UL94: V0

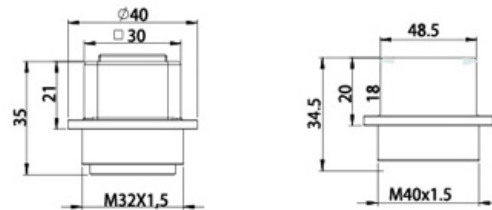

Type	Inserts Small/large	Order No.	PU
CES RVT/M32	Insert Small	600160	5
CES RVT/M40/2	Insert Small	600161	5

CES RVT Split cable glands



Material: Poly carbonate (PC), halogen free
 Color: Light Grey, Black
 Temperature: -30°C-100°C
 Protection level: IP54/IP65 (with gasket and correct selection of the cable inserts)
 Flame Class: UL94: V0

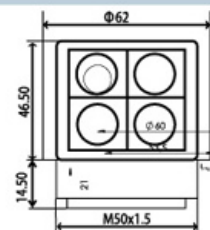

Type	Inserts Small/large	Order No.	PU
CES RVT/M50/4	Insert Small	600162	5
CES RVT/M50/1	Insert Medium	600164	5

KVT 80 Split Cable Glands

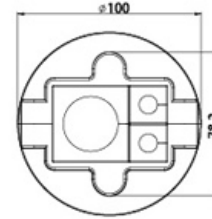

Material: Poly carbonate (PC) screw : stainless steel
 Color: Grey Temperature: -30°C-100°C (static)
 Properties: Halogen-free, silicone-free
 Protection level: IP54 (with gasket and correct selection of the cable inserts)
 Flame Class: UL94: V0 ,self-extinguishing
 Cut-out dimension: 80mm in diameter

Type	Inserts Small/large	Order No.	PU
CES RVT 80/3	Insert Medium/Insert Small	600465	1

KVT 80 Split Cable Glands

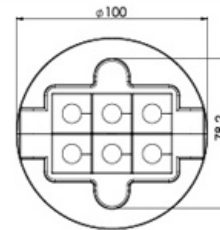
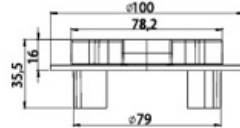

Material: Poly carbonate (PC) screw : stainless steel
 Color: Grey Temperature: -30°C-100°C (static)
 Properties: Halogen-free, silicone-free
 Protection level: IP54 (with gasket and correct selection of the cable inserts)
 Flame Class: UL94: V0 ,self-extinguishing
 Cut-out dimension: 80mm in diameter

Type	Inserts Small/large	Order No.	PU
CES RVT 80/6	Insert Small	600466	1

CES 90 Split Cable Glands

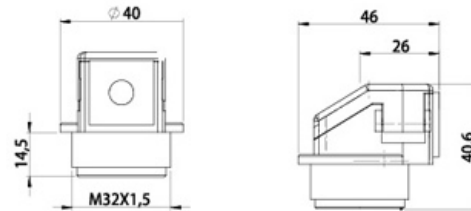

Material: Poly carbonate (PC), halogen free
 Color: Light Grey,Black
 Temperature: -30°C-100°C
 Protection level: IP54/IP65 (with gasket and correct selection of the cable inserts)
 Flame Class: UL94: V0

Type	Inserts Small/large	Order No.	PU
CES RVT 32-W90	Insert Small	600467	10

CES 90 Split Cable Glands

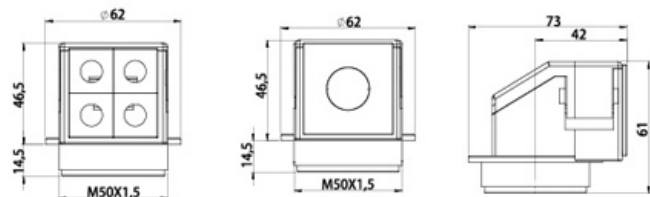

Material: Poly carbonate (PC), halogen free
 Color: Light Grey,Black
 Temperature: -30°C-100°C
 Protection level: IP54/IP65 (with gasket and correct selection of the cable inserts)
 Flame Class: UL94: V0

Type	Inserts Small/large	Order No.	PU
CES RVT 50/4-W90	Insert Small	600468	10
CES RVT 50/1-W90	Insert Medium	600469	10

Split locknut



Material: PA6
 Color: Black
 Temperature: -30°C-100°C
 Protection level: IP54
 Flame Class: UL94: V0

Type	product description	Order No.	PU
CES GMT20	split locknut	600470	10
CES GMT25	split locknut	600471	10
CES GMT32	split locknut	600472	10
CES GMT40	split locknut	600473	10
CES GMT50	split locknut	600474	10

CES Bulk head fittings



Material: Poly carbonate (PC)
 Temperature: -30°C-100°C (static)
 Properties: Halogen-free, silicone-free
 Protection level: IP54
 Flame Class: UL94: V0 ,self-extinguishing

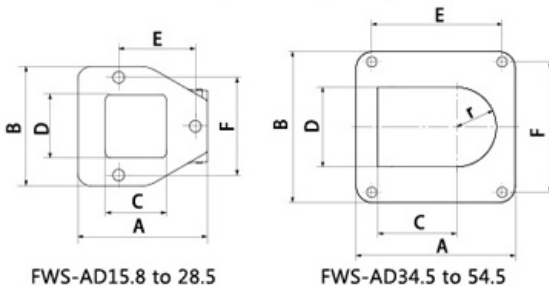

The 90° angled conduit fitting is for installation of parallel corrugated cable protection conduits, for example in machines, control panels or control cabinets. The liftable cover is tightly fixed by a hinge to the mounting box. The system is therefore very easy to handle. CES-FWS will be offered for corrugated conduits with sizes NW 13, 17, 23, 29, 37 and 50.

CES-FWS Assembly



1. Fix FWS with screws



2. Insert conduit with cables



3. Lock FWS with screws

CES-Cable Entry Systems

Type	Hole Φ (mm)	Size (mm)	Cut-out (Cx D)(mm)	Drill. Templ. (E x F)(mm)	Order No.	PU
CES FWS-AD15.8	3x4.3	49x45	22x26.5	29.0x37.0	600475	10
CES FWS-AD21.2	3x4.3	49x45	22x26.5	29.0x37.0	600476	10
CES FWS-AD28.5	3x4.3	67x63	37x28	41.5x51.5	600477	10
CES FWS-AD34.5	4x6.6	85.5x76	41.9x40 r=20	64.5x64.5	600478	10
CES FWS-AD42.5	4x6.6	97x92	48.3x48.4 r=24.2	79.5x79.5	600479	5
CES FWS-AD54.5	4x6.6	111.5x100.5	53x60.5 r=30.25	87.5x87.5	600480	5

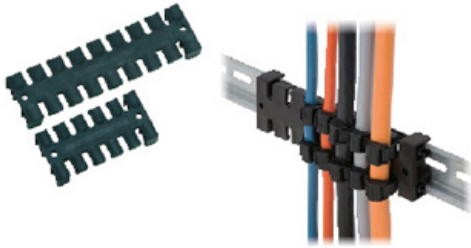
CES ZD Strain relief plates

Material: Nylon 66, halogen free
 Color: Black
 Temperature: -40°C-140°C
 Flame Class: UL94: V0

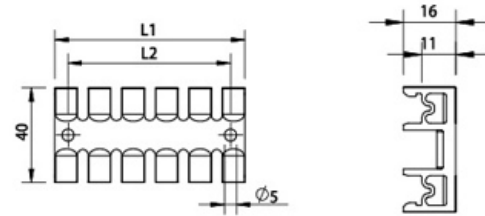

Type	No. of Teeth	Order No.	PU
CES ZD80 (L1: 79, L2: 68)	6	600131	10
CES ZD140 (L1: 139, L2: 128)	9	600132	10

CES ZL Strain relief plates

Material: Nylon 66, halogen free
 Color: Black
 Temperature: -40°C-140°C
 Flame Class: UL94: V0

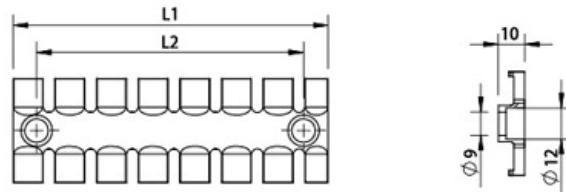

Type	No. of Teeth	Order No.	PU
CES ZL87 (L1: 86.5, L2: 68)	6	600481	10
CES ZL140 (L1: 139.5, L2: 121)	9	600482	10
CES ZL180 (L1: 180, L2: 157)	12	600483	10

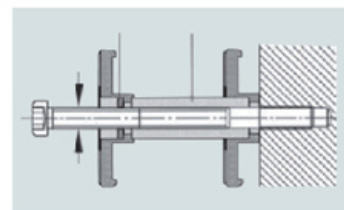
CES DH Distance bushings

Type	Length	Outside diameter	Order No.	PU
CES DH50	50mm	8mm	322511	10

SFN NRG Split corrugated conduit



Material: PA6, PE,PP
 Color: Light Grey, Black, Dark Grey
 Temperature: PA6: -40°C-115°C
 PE: -20°C-80°C PP: -40°C-110°C
 Flame Class: UL94: V2/V0 Customized

Type	Internal/External Diameter(mm)	Order No.	PU
SFN NRG-10.0	6.5x10.0	600499	100
SFN NRG-13.0	10.0x13.0	600500	100
SFN NRG-15.8	12.0x15.8	600501	100
SFN NRG-18.5	14.3x18.5	600502	100
SFN NRG-20.0	16.0x20.0	600503	100
SFN NRG-21.2	17.0x21.2	600504	50
SFN NRG-25.0	21.0x25.0	600505	50
SFN NRG-28.5	23.0x28.5	600506	25
SFN NRG-30.0	25.0x30.0	600507	25
SFN NRG-34.5	29.0x34.5	600508	25
SFN NRG-42.5	36.0x42.5	600509	10
SFN NRG-54.5	48.0x54.5	600510	10
SFN NRG-67.2	56.3x67.2	600511	25
SFN NRG-80.0	66.5x80.0	600512	10
SFN NRG-106.0	91.0x106.0	600513	10

SFN NRG Standard corrugated conduit



Material: PA6, PE,PP
 Color: Light Grey, Black, Dark Grey
 Temperature: PA6: -40°C-115°C
 PE: -20°C-80°C PP: -40°C-110°C
 Flame Class: UL94: V2/V0 Customized

Type	Internal/External Diameter(mm)	Order No.	PU
SFN NRG-10.0	6.5x10.0	600484	100
SFN NRG-13.0	10.0x13.0	600485	100
SFN NRG-15.8	12.0x15.8	600486	100
SFN NRG-18.5	14.3x18.5	600487	100
SFN NRG-20.0	16.0x20.0	600488	100
SFN NRG-21.2	17.0x21.2	600489	50
SFN NRG-25.0	21.0x25.0	600490	50
SFN NRG-28.5	23.0x28.5	600491	25
SFN NRG-30.0	25.0x30.0	600492	25
SFN NRG-34.5	29.0x34.5	600493	25
SFN NRG-42.5	36.0x42.5	600494	10
SFN NRG-54.5	48.0x54.5	600495	10
SFN NRG-67.2	56.3x67.2	600496	25
SFN NRG-80.0	66.5x80.0	600497	10
SFN NRG-106.0	91.0x106.0	600498	10

CES Cable ties with hook-and-loop fastener



Type	Size (mm)			Order No.	PU
	L	B1	B2		
CES LKB 200x7bk	200	13	7	600514	100
CES LKB 200x13bk	200	20	13	600515	100

CES Cable ties with hook-and-loop fastener

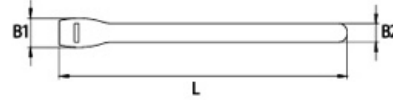

Type	Size (mm)			Order No.	PU
	L	B1	B2		
CES LKB 230x13bk	230	20	13	600516	100
CES LKB 300x17bk	300	25	17	600517	100

CES Cable ties with hook-and-loop fastener



Material: Polypropylene + Velour PA
 Color: Black
 Temperature: -30°C-80°C
 Flame Class: UL: V0/V2

Type	Size (mm)			Order No.	PU
	L	B1	B2		
CES LB 7bk			7	600518	25
CES LB 10bk			10	600519	25
CES LB 15bk			15	600520	25
CES LB 20bk			20	600521	25
CES LB 25bk			25	600542	25

CES Holder for hook-and-loop fastener, screwable

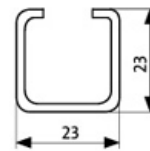
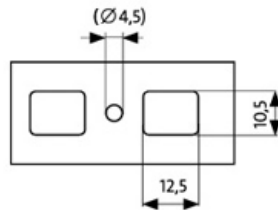
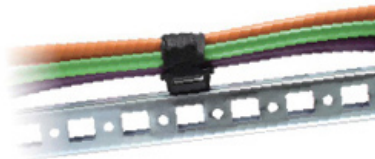

23x23mm Installation Guide



CES BH-R



CES BH-SB

Material: Nylon 66, halogen free
 Color: Black
 Temperature: -40°C-140°C
 Flame Class: UL94: V0

Type	Fit for LKB/LB	Order No.	PU
CES BH-R	LKB 200x7/LKB 200x13/LB 10/LB 15	600522	100
CES BH-SB	LKB 200x7/LB 10	600523	100

CES Holder for hook-and-loop fastener, assemble and KD by turning 90°



CES BH-RBA

Material: Nylon 66, halogen free
 Color: Light Grey
 Temperature: -40°C-140°C
 Flame Class: UL94: V0
 Cut-out dimension: Ø6mm



CES BH-RBB

Material: Nylon 66, halogen free
 Color: Black
 Temperature: -40°C-140°C
 Flame Class: UL94: V0
 Cut-out dimension: Ø6.5mm

Type	Fit for LKB/LB	Order No.	PU
CES BH-RBA	LKB 200x7/LB 10	600525	100
CES BH-RBB	LKB 200x7/LB 10	600526	100

CES small



Material: TPE halogen free
 Color: Light Grey, Black
 Temperature: -40°C-140°C
 Protection level: IP54
 Flame Class: UL94: V0

Type	Clamping range mm	Order No.		PU
		Grey	Black	
CES 2	2-3	600302	601302	5
CES 3	3-4	600303	601303	5
CES 4	4-5	600304	601304	5
CES 5	5-6	600305	601305	5
CES 6	6-7	600306	601306	5
CES 7	7-8	600307	601307	5
CES 8	8-9	600308	601308	5
CES 9	9-10	600309	601309	5
CES 10	10-11	600310	601310	5
CES 11	11-12	600311	601311	5
CES 12	12-13	600312	601312	5
CES 13	13-14	600313	601313	5
CES 14	14-15	600314	601314	5
CES 15	15-16	600315	601315	5
CES 16(S)	16-17	600316(S)	601316(S)	5

CES medium



Material: TPE halogen free
 Color: Light Grey, Black
 Temperature: -40°C-140°C
 Protection level: IP54
 Flame Class: UL94: V0

Type	Clamping range mm	Order No.		PU
		Grey	Black	
CES 16(M)	16-17	600316(M)	601316(M)	5
CES 17	17-18	600317	601317	5
CES 18	18-19	600318	601318	5
CES 19	19-20	600319	601319	5
CES 20	20-21	600320	601320	5
CES 21	21-22	600321	601321	5
CES 22	22-23	600322	601322	5
CES 23	23-24	600323	601323	5
CES 24	24-25	600324	601324	5
CES 25	25-26	600325	601325	5
CES 26	26-27	600326	601326	5
CES 27	27-28	600327	601327	5
CES 28	28-29	600328	601328	5
CES 29	29-30	600329	601329	5
CES 30	30-31	600330	601330	5
CES 31	31-32	600331	601331	5
CES 32	32-33	600332	601332	5
CES 33	33-34	600333	601333	5

CES adapter insert(small)

Material: TPE halogen free
 Color: Light Grey, Black
 Temperature: -40°C-140°C
 Protection level: IP54
 Flame Class: UL94: V0

Type	Clamping range mm	Order No.		PU
		Grey	Black	
CES 2/3	2xΦ3	600334	601334	5
CES 2/4	2xΦ4	600335	601335	5
CES 2/5	2xΦ5	600336	601336	5
CES 2/6	2xΦ6	600337	601337	5
CES 2/7	2xΦ7	600338	601338	5
CES 2/8	2xΦ8	600339	601339	5
CES 4/3	4xΦ3	600340	601340	5
CES 4/4	4xΦ4	600341	601341	5
CES 4/5	4xΦ5	600342	601342	5
CES 4/6	4xΦ6	600343	601343	5

Drilling, wide cable range

Material: TPE halogen free
 Color: Light Grey, Black
 Temperature: -40°C-140°C
 Protection level: IP54
 Flame Class: UL94: V0

Type	Clamping range mm	Size	Order No.	PU
KTMB 6.5	2.5-6.5	CES small	600527	5
KTMB 7.5	4-7.5	CES small	600528	5
KTMB 10	6.5-10	CES small	600529	5
KTMB 13	9.5-13	CES small	600530	5
KTMB 16	13-16	CES small	600531	5

Drilling, wide cable range

Material: TPE halogen free
 Color: Light Grey, Black
 Temperature: -40°C-140°C
 Protection level: IP54
 Flame Class: UL94: V0

Type	Clamping range mm	Size	Order No.	PU
CES DPF-A	3-12	CES small	600532	5

CES DT Cable entry inserts



Material: TPE halogen free
Color: Light Grey, Black
Temperature: -40°C-140°C
Protection level: IP54
Flame Class: UL94: V0

Type	Clamping range mm	Size	Order No.	PU
KTMB 18	13-18	CES medium	600533	5
KTMB 23	18-23	CES medium	600534	5
KTMB 28	23-28	CES medium	600535	5
KTMB 33	28-33	CES medium	600536	5

Cable Entry Inserts, multi range



Material: TPE halogen free
Color: Light Grey, Black
Temperature: -40°C-140°C
Protection level: IP54
Flame Class: UL94: V0

Type	Clamping range mm	Size	Order No.	PU
KTMB2x18	2x13-18	CES medium	600537	5

Cable Entry Inserts, multi range



Material: TPE halogen free
Color: Light Grey, Black
Temperature: -40°C-140°C
Protection level: IP54
Flame Class: UL94: V0

Type	Clamping range mm	Size	Order No.	PU
CES DPF-B	4-18	CES medium	600538	5
CES DPF-C	11-23	CES medium	600539	5
CES DPF-D	14-26	CES medium	600540	5

Cable Entry Inserts, multi range



Material: TPE halogen free
Color: Light Grey, Black
Temperature: -40°C-140°C
Protection level: IP54
Flame Class: UL94: V0

DT cable entry inserts are designed for routing standard cables (wireless connector)

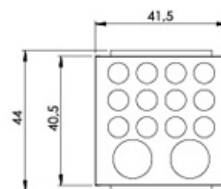

CES DT1

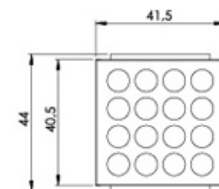

CES DT2

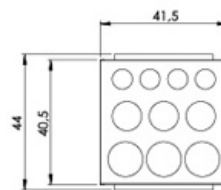

CES DT3

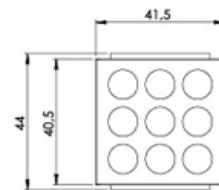

CES DT4

Type	Cable number	Order No.	PU
CES DT1	12x max.6.5mm/2x max.12.2mm	600460	10
CES DT2	16x max.7.1mm	600461	10
CES DT3	4x max.6.5/3x max.9.5/3x max.11.3mm	600462	10
CES DT4	9x max.9.5mm	600463	10

CES Conversion template

Material: TPE halogen free
 Color: Light Grey, Black
 Temperature: -40°C-140°C
 Protection level: IP54
 Flame Class: UL94: V0

Type	Size	Order No.		PU
		Grey	Black	
CES BSA	conversion template from large to small	600344	601344	5
CES BSG	solid template small	600345	601345	5
CES BBG	solid template medium	600346	601346	5

CES plugs for sealing

Material: Nylon 66 halogen free
 Color: white
 Flame Class: UL94: V0

Type	Diameter mm	length mm	Order No.	PU
CES PT2	2	25	600402	5
CES PT3	3	25	600403	5
CES PT4	4	25	600404	5
CES PT5	5	25	600405	5
CES PT6	6	25	600406	5
CES PT7	7	25	600407	5
CES PT8	8	20	600408	5
CES PT9	9	20	600409	5
CES PT10	10	20	600410	5
CES PT11	11	20	600411	5
CES PT12	12	20	600412	5
CES PT13	13	20	600413	5
CES PT14	14	20	600414	5
CES PT15	15	20	600415	5
CES PT16	16	20	600416	5
CES PT17	17	20	600417	5